

HT-Innenentwässerung

Das komplette Programm. Einfache Steckmontage, deshalb schnell und sauber zu verlegen!

- Rohre und Formstücke für Abwasserleitungen innerhalb von Gebäuden nach DIN EN 1451 - 1
- heißwasserbeständig bis 90°C
- für heiße, kalte und aggressive Abwässer geeignet
- einfach Steckmuffen-Verbindung
- schnell und rationell zu verlegen mit geringem Gefälle
- Nennweiten DN 32/40/50/75/90/110
- Material: schwer entflammables Polypropylen = PP nach DIN 4102/B1
- Farbe: Staubgrau RAL 7037

Toilette

Montage der Abwasserrohre unterhalb der Decke. Spülkasten nicht eingebaut.

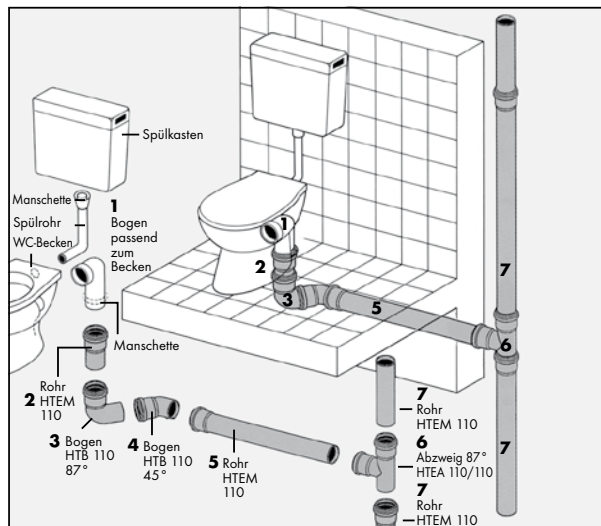

Waschbecken

Verlegung der Abwasserrohre im Mauerschlitze. Anschluss unter der Decke.

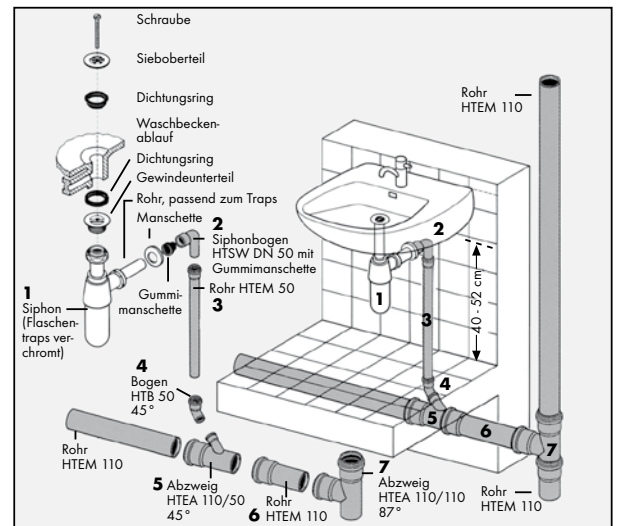

Dusche

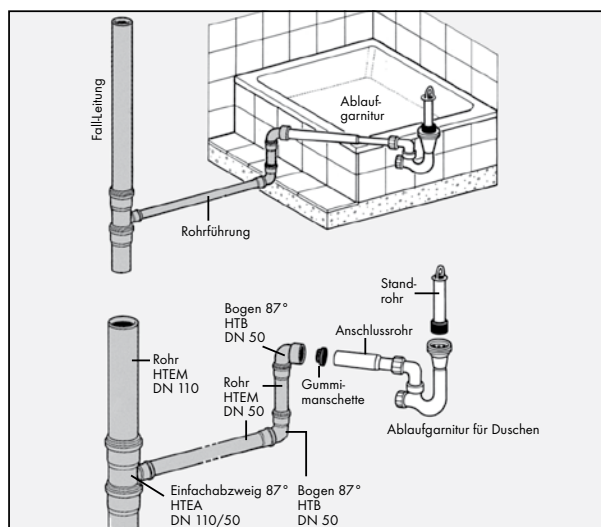

Spüle und Geschirrspüler

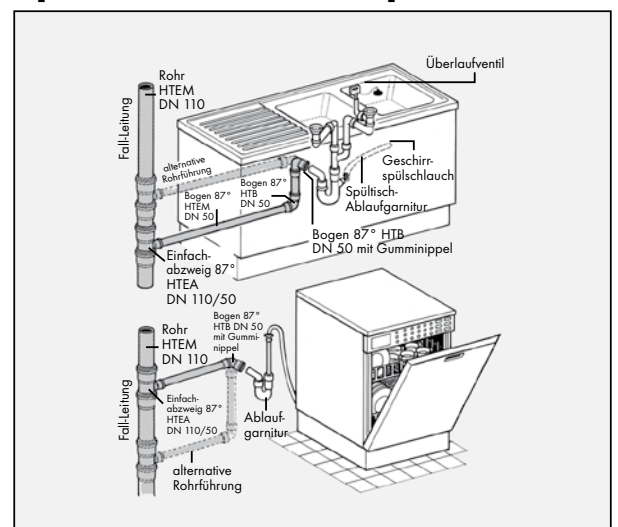









Unseren Produktfilm
HT-Rohrleitungssystem verlegen
 auf Ihrem Smartphone ansehen!













Weitere Informationen unter
www.marley.de















Mach's mit Marley.

Marley HT-Innenentwässerung

Das HT-Programm zur einfachen Steckmontage.
Mit vormontierter Lippendichtung.

Artikel	DN	EAN-Nr. 4002644...	Menge
HTEM Rohre mit Steck- muffe 	150 mm	40	090023
		50	090030
		75	090047
		110	090054
	250 mm	32	090115
		40	090122
		50	090139
		75	090146
		90	090160
		110	090153
	500 mm	32	090214
		40	090221
		50	090238
		75	090245
90		090269	
110		090252	
1000 mm	32	090412	
	40	090429	
	50	090436	
	75	090443	
	90	090467	
	110	090450	
2000 mm	32	090818	
	40	090825	
	50	090832	
	75	090849	
	90	090900	
	110	090856	
HTB Bogen 15° 	32	091105	
	40	091129	
	50	091136	
	75	091143	
	90	091174	
HTB Bogen 30° 	32	091204	
	40	091228	
	50	091235	
	75	091242	
	90	091273	
HTB Bogen 45° 	32	091303	
	40	091327	
	50	091334	
	75	091341	
	90	091372	
HTB Bogen 67° 	32	091402	
	40	091426	
	50	091433	
	75	091440	
	90	091471	
HTB Bogen 87° 	32	091600	
	40	091624	
	50	091631	
	75	091648	
	90	091662	
HTEA Einfach- Abzweig 45° 	32/32	091709	
	40/40	091716	
	50/40	091723	
	50/50	091730	
	75/50	091754	
	75/75	091761	
	90/50	091679	
	90/75	091686	
	90/90	091693	
	110/50	091778	
110/75	091785		
HTEA Einfach- Abzweig 67° 	32/32	091792	
	40/40	091815	
	50/40	091822	
	50/50	091839	
	75/50	091853	
	75/75	091860	
	110/50	091877	
	110/75	091884	
	110/110	091891	

Artikel	DN	EAN-Nr. 4002644...	Menge
HTEA Einfach- Abzweig 87° 	32/32	091907	
	40/40	091914	
	50/40	091921	
	50/50	091938	
	75/50	091952	
	90/50	092003	
	90/75	092010	
	90/90	092027	
	75/75	091969	
	110/50	091976	
	110/75	091983	
	110/110	091990	
	HTDA Doppel- Abzweig 67° 	50/50/50	092126
		75/75/75	092133
90/90/90		092188	
110/50/50		092140	
HTED Eck- abzweig 67° 	110/110/110	092164	
	110/110/110	092171	
HTR Über- gangsrohr exzentrisch 	40/32	092300	
	50/32	092317	
	50/40	092324	
	75/50	092348	
	90/50	092270	
	110/50	092355	
	110/75	092362	
	110/90	092294	
	110/50	513683	
	HTR Über- gangsrohr kurz exzentrisch 	110/75	513690
HTL Lang- muffe (2½ fach) 	40	092423	
	50	092430	
	75	092447	
	90	092478	
	110	092454	
HTU Überschie- bemuffe 	32	092508	
	40	092522	
	50	092539	
	75	092546	
	90	092577	
	110	092553	
HTR E Reinigungs- rohr 	50	092737	
	75	092744	
	90	092775	
	110	092751	
HTM Muffen- stopfen 	32	092805	
	40	092829	
	50	092836	
	75	092843	
	90	092874	
	110	092850	
HTSW Siphon- Winkel 90° 	30/30	099293	
	40/30	092928	
	40/40	092935	
	50/40	092942	
	50/50	092959	
	40/50/40	092966	
HTDSB Doppelsiphon- Bogen 90° 			
HTS Anschluss- stück am Metallrohr 	32/32	098791	
	40/40	093024	
	50/40	093031	
	50/50	093048	
	50	093352	
HTUG Anschlussstück an Gussrohre 	75	093369	
	110	093376	

Artikel	DN	EAN-Nr. 4002644...	Menge
HT-Schelle, verzinkt 	40	093628	
	50	093635	
	75	093642	
	110	093659	
HT-Schelle, mit Gewindestift 8 x 80 mm 	40	093666	
	50	093673	
	75	093680	
	110	093697	
Gleitmittel	150 ml	093963	
HT-Schelle schallgedämmt mit Stock- schraube, 8 x 80 mm 	40	093765	
	50	093772	
	75	093789	
	90	093802	
	110	093796	
HTGM, Gummi- manschette für Siphon- bogen 90°, Doppelsiphon und HTS 	für NW 30/30	30/30	094632
	40/30	40/30 A	094649
	40/40	40/30 B	094656
	50/40	40/40 C	094663
	50/50	50/30 D	094670
	50/40 E	094687	
	50/50 F	094694	
Gumminippel mit Sickenwulst für Metall- oder Bleirohre 	40 - 1 1/4"	094700	
	50 - 1 1/4"	094717	
	50 - 1 1/2"	094724	
Doppeldichtung für MuffenGuss- rohr 	50	094731	
	75	094748	
	110	094755	
Ersatz- Dichtring 	32	094809	
	40	094762	
	50	094779	
	75	094786	
	90	094816	
	110	094793	
HT-Flex- schlauch 	250 mm	50	093918
	500 mm	50	093925
	750 mm	50	093932
	1000 mm	50	093949
HT-Rohrbelüfter 	32/40/50	093833	
	75/90/110	093840	
Einfach-Rückstau- verschluss ERV 50 	50	093895	
Dunstrohr- anschluss 	50/75/110	093901	
HT-Innenreduktion zum Anschluss von HT-Rohren DN 50 und 75 an Rohrenden DN 110. 	110-50	092614	
	110-75	092621	
Rohrverbinder 	24-32/32-40	338064	
	24-32/40-50	338071	
	32-40/40-50	338187	
	40-50/53-63	338286	
	40-50/75-89	338293	
	40-50/100-115	338309	
	75-89/100-115	338101	
	100-115/110-125	338156	
	100-115/121-136	338149	
	110-125/144-160	338163	
Übergang 	24-32	338088	
	32-40	338194	
	42-50	338316	
	55-65	338118	
	75-89	338231	
	105-120	338262	
Kupplung 